

बिहार सरकार

ग्रामीण विकास विभाग

पत्रांक 209202
ग्रा0वि07(नि0)-17/2014

पटना, दिनांक 20/11/2014

प्रेषक,

एस0 एम0 राजू0,
सचिव ।

सेवा में,

सभी जिला पदाधिकारी-सह-जिला कार्यक्रम समन्वयक,
सभी उप विकास आयुक्त-सह-अपर जिला कार्यक्रम समन्वयक,
बिहार ।

विषय:- मनरेगा योजना अंतर्गत पेय जल स्रोतों समेत भू-जल के पुर्नस्थापन पर Special Focus के संबंध में ।

प्रसंग:- भारत सरकार, ग्रा0वि0मंत्रा0 का पत्र क्र0 11017/40/2011-MGNREGA(UN) दिनांक 07.08.2014 (छायाप्रति संलग्न) ।

महाशय,

विषयान्तर्गत भारत सरकार, ग्रामीण विकास मंत्रालय के प्रासंगिक पत्र द्वारा अधिनियम के अध्याय-1 के अनुसार जल संरक्षण एवं संचयन की संरचना को बढ़ावा तथा भू-जल के पुनर्स्थापन पर मनरेगा योजना अंतर्गत **Special Focus** के संबंध में पत्र प्राप्त हुआ है। जिसके तहत Roof-Top rain water harvesting structure तथा वैसे वोरबेल जिनसे पेयजल की आपूर्ति की जाती है, उनके Aquifer को रिचार्ज करने हेतु Recharge Structure को मनरेगा के तहत अधिमान्य योजनाओं की सूची में रखा जाएगा।

मनरेगा निधिक परियोजनाओं के लिए वर्षा जल संचयन के मॉडल अभिकल्प के संबंध में विस्तृत दिशा-निर्देश भारत सरकार, ग्रामीण विकास मंत्रालय का पत्र क्र0 11017/40/2011-MGNREGA(UN) दिनांक 26.06.2014 (छायाप्रति संलग्न) जारी किये गये हैं ।

अनुरोध है कि भारत सरकार, ग्रामीण विकास मंत्रालय से प्राप्त पत्र के आलोक में अपने जिला अन्तर्गत सभी प्रखंडों / कार्यान्वयन एजेंसी तथा पंचायती राज संस्थाओं के कर्मियों / प्रतिनिधियों को निदेश दिया जाय ।

अनु0- यथोक्त ।

विश्वासभाजन

(एस0 एम0 राजू0)

सचिव



19/11/14



No. 11017/40/2011-MGNREGA (UN)
Ministry of Rural Development
Department of Rural Development
(Mahatma Gandhi NREGA Division)

Krishi Bhavan, New Delhi
Dated: 7th August, 2014.

All the Spl CSs/Pri Secretaries/Secretaries of Rural Development (In charge-MGNREGS)

Subject: Special focus on recharging ground water including drinking water sources.

Sir/Madam,

As per schedule-I of the Act, the water conservation and water harvesting structures to augment and improve groundwater constitute a special focus area for MGNREGA works. In this regard, the copy of the Select Rain Water Harvesting Model designs furnished by the Ministry of Water Resources were shared with all the States vide this Ministry letter No. 11017/40/2011-MGNREGA (UN) dated 26th June, 2014, with a request to disseminate them to the RD & PRI functionaries.

Further, considering the need to mitigate the adverse effects of a drought-like situation, an advisory has already been issued to focus on water conservation works. The matter was further reviewed in an inter-Ministerial meeting of Government of India and the following have been advised:

a) Roof top rain water harvesting structures may be taken up under MGNREGS in all the Gram Panchayats, wherever drinking water schemes are dependent on bore-wells, and/or recharge structures should be taken up under MGNREGA. For this purpose, the borewell recharge structures taken up by Andhra Pradesh/TeLANGANA, which were evaluated and recommended by the Central Ground Water Board, may be used as a National model.

b) All State Governments are requested to act in accordance with the above advice and plan for recharging of the ground water sources and ensure adequate water availability in the forthcoming summer season.

Yours faithfully

(R. Subrahmanyam)

Encl. Model Design of borewell (444444)
Recharging structure

1912
1000000 MGNREGA
26 JUN 2014
All the Spl CSs/Pri Secretaries/Secretaries of Rural Development (In charge-MGNREGS)

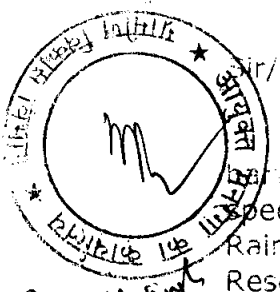

Sri A.M. Singh
Shri Rajiv Kumar
PO

Pl.
11.9.14

12-X-14

Borewell recharge structure

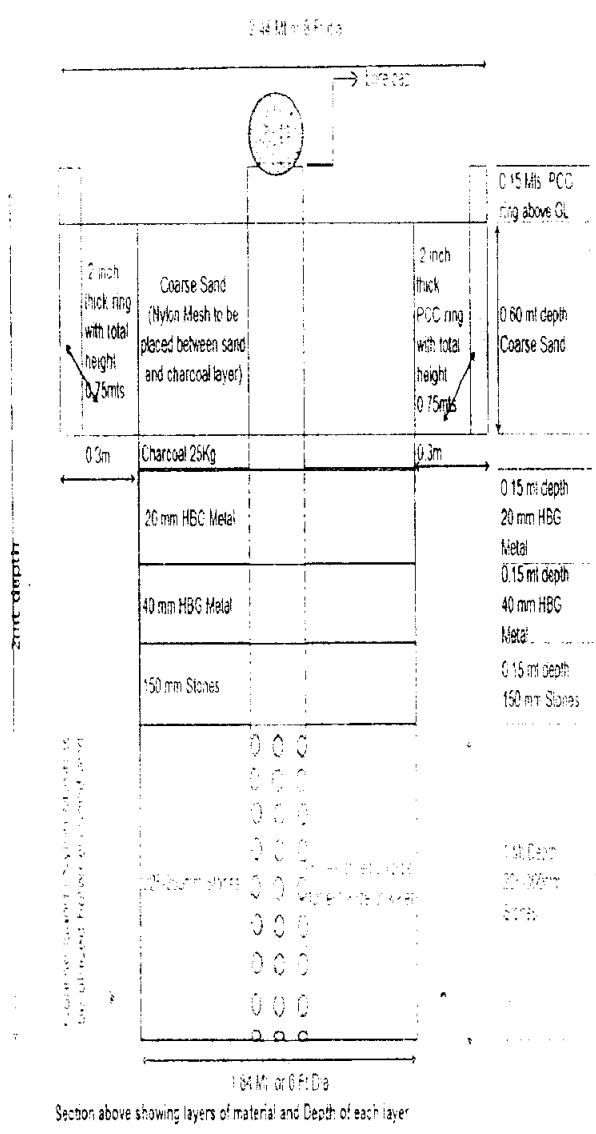

- Suitable for 2 acres borewell catchment area
- Reduction in Fluoride content significantly.
- Suitable for any depth of Borewell.
- takes 1 to 2 years to stabilize & can withstand 2 to 3 years of drought
- Cost for 10 ft x 10 ft x 10 ft recharge pit is approx Rs. 30,000/-.

Estimate

DETAILED CUM ABSTRACT ESTIMATE of Brick masonry Circular Ring of Dia 2.44Mt (8Ft)						
Name of Work :- Construction of Borewell Recharge Structure using PCC Ring						
Sl. NO	TASK CODE	Description of Item	Qty upper limit	Unit	Rate	Total cost
1	00027	Earth work excavation for recharge pit (6.53 cum) silt trap (1.3 cum), Drain (1.5 cum)	9.33	Cu.Mt	78.26	730
2	00028	Dry stone packing using 225-300 mm size including cost and conveyance	5.22	Cu.Mt	1368.95	7146
4	00029	Collection and supply of laterite metal 150 mm thick for filter media including cost and conveyance	0.40	Cu.Mt	656	262.4
5	00030	Collection and supply of 40 mm HGB metal for filter media including cost and conveyance	0.4	Cu.Mt	1193.5	477.40
6	00031	Collection and supply of 20 mm HGB metal for filter media including cost and conveyance	0.4	Cu.Mt	1623.5	649.40
7	00032	Collection and supply of coarse sand including cost and conveyance	2.8	Cu.Mt	588	1646.40
8	00033	Collection and supply of charcoal (in Kilogram) including cost and conveyance	25	KG	40	1000
9	00034	P.C.C (1:2.5:5) using 20mm HBG metal including cost and conveyance of all materials and all labour charges etc complete for filter media for casing pipe plugging	0.04	Cu.Mt	3588.97	143.559
10		Brick masonry in CM(1:5) for Borewell recharge structure ring using country bricks including cost & conveyance of all materials etc for 1 Cum. Complete	0.63	Cu.Mt	2992.53	1885.29
11		Plastering with CM (1,5)mix, 12 mm including cost and conveyance of all materials etc for 10 Sqm etc , complete	6.44	Sq.mt	254.16	1636.79
12	00037	Provision for VAT 4.00% on material cost				623
13	00038	unforeseen items, if any				1210
	00039	Bore-well recharge Filter Material with AQUAMESH (3,200), NYLON MESH (3,200), HDPE Net (4000), Casing pipe holding bracket with bolts and nuts (640) and Filters Binding material(800).	1	Set		11840
		Total Cost				29250

600/14/19-42
19/7/14

No. 11017/40/2011-MGNREGA (UN)
Government of India
Ministry of Rural Development
Department of Rural Development
(Mahatma Gandhi NREGA Division)

Krishi Bhavan, New Delhi
Dated 26 June, 2014.

NARAYAN

CE

3140
17/8/14

To: The Spl CSs/Pri Secretaries/Secretaries of Rural Development (In charge-MGNREGS),
Government of

Subject: Artificial Recharge and Rain Water Harvesting under MGNREGA.

Sir/Madam,

As per schedule-I, of the Act, the water conservation and water harvesting structures to augment and improve groundwater, watershed management work and renovation of traditional water bodies works are permitted under MGNREGA, which can mitigate the effect of drought.

2. To execute water harvesting and watershed management works, a watershed works manual for MGNREGS was prepared by the Samaj Pragati Sahayog (SPS) for the Ministry. Hard copies of this manual was sent to all the states and it is also uploaded on Ministry website nrega.nic.in under the head Engineers. In this manual, different types of water harvesting and watershed management works have been detailed systematically covering all aspects i.e. objectives, location, design, planning, layout, Dos and DONTs etc.

3. Ministry of Water Resources has now furnished modular designs of Artificial Recharge and Rain Water Harvesting, which have been prepared depending upon the suitability of the terrain in the country & categorized into three parts, as follows:-

- i) **Hilly and Inter -mountainous Area:** Percolation Tanks, Modification of Village tanks as recharge structure, Gabion Structure, Contour Bunds (Himachal Pradesh, Jammu & Kashmir, Uttarakhand, Sikkim and North Eastern States)
- ii) **Alluvial Area:** Percolation Tanks, Recharge Pits (Punjab, Haryana, Uttar Pradesh, Bihar, and West Bengal)
- iii) **Hard Rock Area:** Recharge through Abandoned Dug Wells/ Bore wells/ Tube Wells, Modification of Village tanks as recharge structure, Gabion structure, Percolation Tanks (Madhya Pradesh, Maharashtra, Karnataka, Tamil Nadu, Andhra Pradesh and Kerala)

4. The copy of the Select Rain Water Harvesting Model Designs furnished by the Ministry of Water Resources is enclosed, with a request to disseminate these Model designs to RD & PRI functionaries in areas, where there is scope for taking up these works.

5. Action taken in this regard may be conveyed to this Ministry by 15th July, 2014.

Enclosed: As above

Yours faithfully

(R. Subrahmanyam)

Copy to: The Secretary, Ministry of Water Resources, Government of India, for information.

Joint Secretary (RE-1)

दिनांक: 26/6/14
क्र.सं: 976
118150
11/8/14

59/210004
06/08/14

EE

A
218
A. Patel

17/8/14
(PKK)
(E)



जल संसाधन मंत्रालय
भारत सरकार

MINISTRY OF WATER RESOURCES
GOVERNMENT OF INDIA

मनरेगा निधिक परियोजनाओं
के लिए
वर्षा जल संचयन के माडल अभिकल्प

Select Rain Water Harvesting Model Designs
for
MGNREGA Funded Projects

नई दिल्ली
NEW DELHI

RAIN WATER HARVESTING MODEL DESIGNS FOR CONSIDERATION UNDER MGNREGA FUNDED PROJECTS.

Rain Water Harvesting Model designs, depending upon the suitability of the terrain, which can be considered under MGNREGA funded projects are as follows :-

- **Hilly and Inter-mountainous area-** Percolation Tanks, Modification of Village tanks as recharge structure, Gabion Structure, Contour Bunds (Himachal Pradesh, Jammu & Kashmir, Utrakhand, Sikkim & North Eastern States)
- **Alluvial Area-** Percolation Tanks, Recharge Pits (Punjab , Haryana, Uttar Pradesh, Bihar, West Bengal)
- **Hard Rock Area-** Recharge through Abandoned Dug Wells/ Bore Wells/ Tube Wells, Modification of Village tanks as recharge structure, Gabion Structure, Percolation Tanks (Madhya Pradesh, Maharashtra, Karnataka, Tamil Nadu, Andhra Pradesh, Kerala)

The description of these structures along with designs is as under:-

1. PERCOLATION TANKS (PT) / SPREADING BASIN

Percolation tanks are among the most common runoff harvesting structures in India. A percolation tank can be defined as an artificially created surface water body submerging a highly permeable land area so that the surface runoff is made to percolate and recharge the ground water storage. They are not provided with sluices or outlets for discharging water from the tank for irrigation or other purposes. They may, however, be provided with arrangements for spilling away the surplus water that may enter the tank so as to avoid over-topping of the tank bund.

The hydrogeological condition of site for percolation tank is of utmost importance. The rocks coming under submergence area should have high permeability. The degree and extent of weathering of rocks should be uniform and not just localized. The purpose of percolation tank is to conserve the surface run off and diverts the maximum possible surface water to the ground water storage. Thus the water accumulated in the tank after monsoon should percolate at the earliest, without much evaporation losses.

A percolation tank is designed to ensure maximum capacity utilization, long life span, cost effectiveness and optimum recharge to groundwater. Storage capacity, waste weir, drainage arrangement and cut off trench (COT) are the important features of percolation tank which need proper design. The overall design of the percolation tank is similar to an earthen dam constructed for minor irrigation without canal.

These are the most prevalent structures in India as a measure to recharge the ground water reservoir both in alluvial as well as hard rock formations. The efficacy and feasibility of these structures is more in hard rock formation where the rocks are highly fractured and weathered. In the States of Maharashtra, Andhra Pradesh, Madhya Pradesh, Karnataka and Gujarat, the percolation tanks have been constructed in plenty in basaltic lava flows and crystalline rocks.

The percolation tanks are however also feasible in all hard rock terrain with weathered thickness of minimum of 5 m, all soft rock terrain with top clay of maximum 3 m. thickness and in mountain fronts occupied by talus scree deposits. The percolation tanks are feasible structures in the

18)

States of Himachal Pradesh, Jammu & Kashmir, Uttarakhand, Sikkim, North Eastern States, Punjab, Haryana, Uttar Pradesh, Bihar, West Bengal, Madhya Pradesh, Maharashtra, Karnataka, Tamil Nadu, Andhra Pradesh, Kerala.

Percolation tanks are to be normally constructed on second or third order streams, as the catchment area of such streams would be of optimum size. The location of tank and its submergence area should be in non-cultivable land and in natural depressions requiring lesser land acquisition. There should be cultivable land downstream of the tank in its command with a number of wells to ensure maximum benefit by such efforts. Steps should be taken to prevent severe soil erosion through appropriate soil conservation measures in the catchment. This will keep the tank free from siltation which otherwise reduces the percolation efficiency and life of the structure.

The catchment yield and basin configuration drawn from topographic surveys at site determine the height of the percolation tank. The top of dam wall is normally kept 2-3 m wide. Upstream and downstream slopes of the dam wall are normally taken as 2.5:1 and 2:1 respectively. The design particular of a typical percolation tank is shown below along with all relevant details.

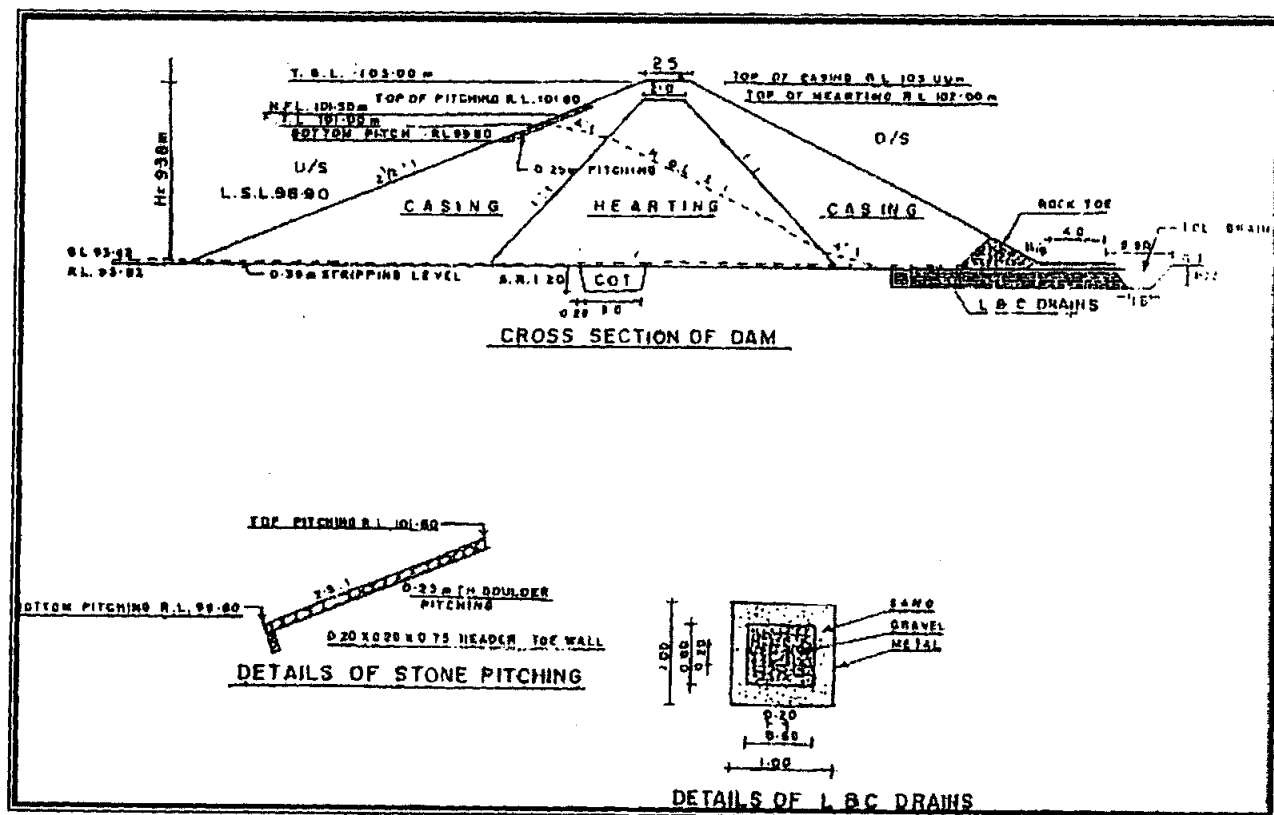

Design Aspects of a Typical Percolation Pond

Design of Tank Bund: The tank bund, for all practical purposes, is a small-sized earthen dam and its design and construction should be carried out in accordance with the principles applicable to earthen dams.

The bunds of a percolation pond may be of three types, i.e.

- Type A: Homogeneous embankment type
- Type B: Zoned Embankment Type
- Type C: Diaphragm Type

Tank bunds in India are mostly of Type A and are constructed with soils excavated from pits in the immediate vicinity of the bund and transported to the bund.

The Common Types of Bunds of Percolation Ponds are shown below

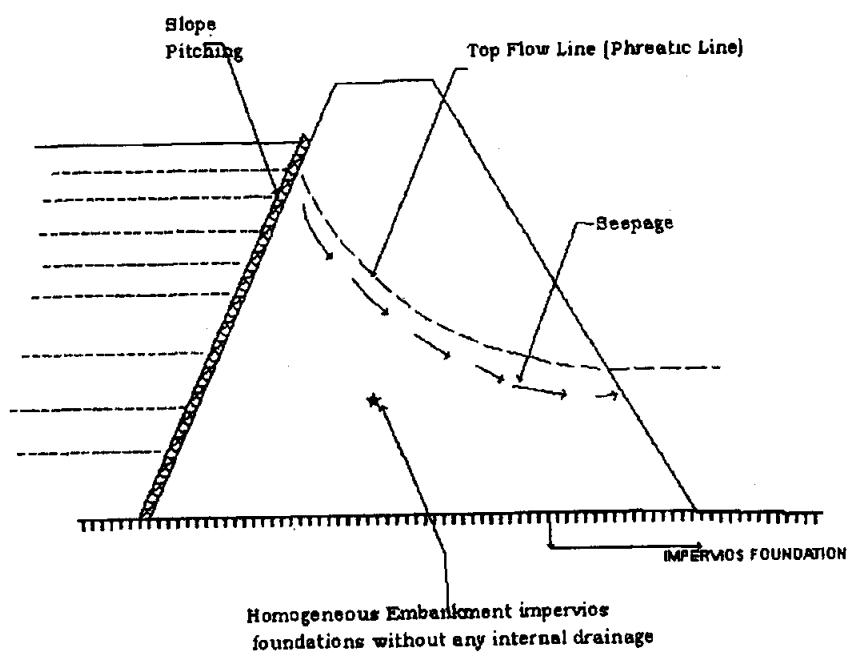

Type A- Homogeneous Type

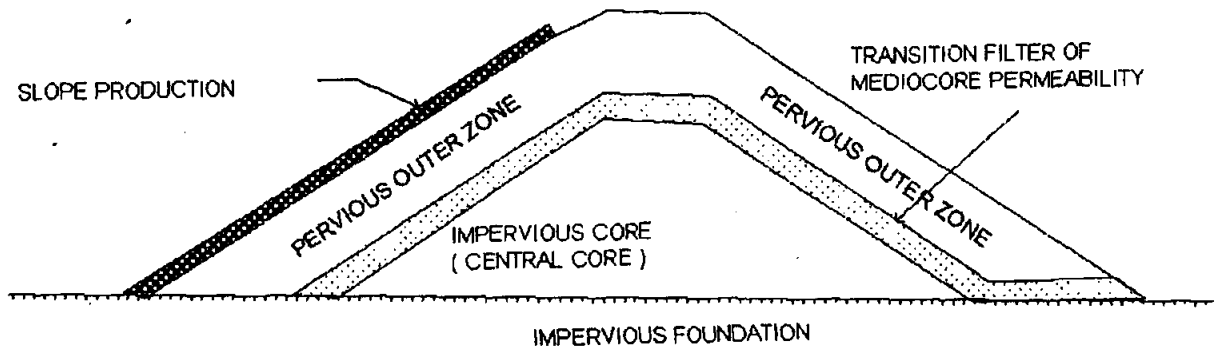

Type B -Zoned Type

16)

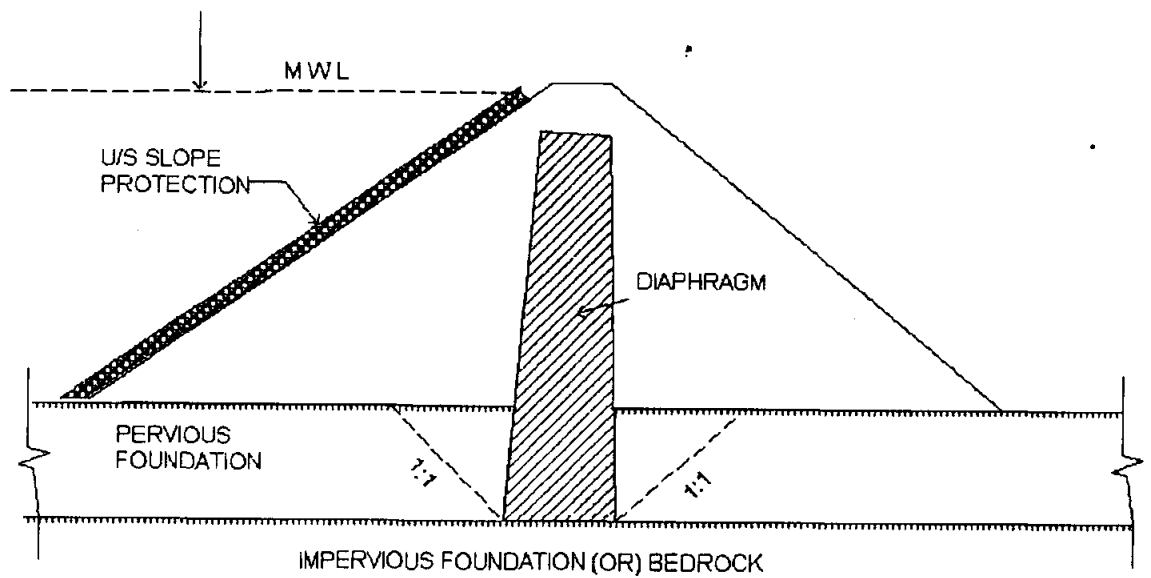

Type C- Diaphragm Type

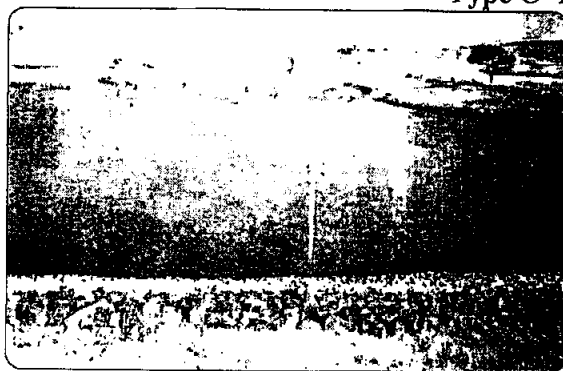
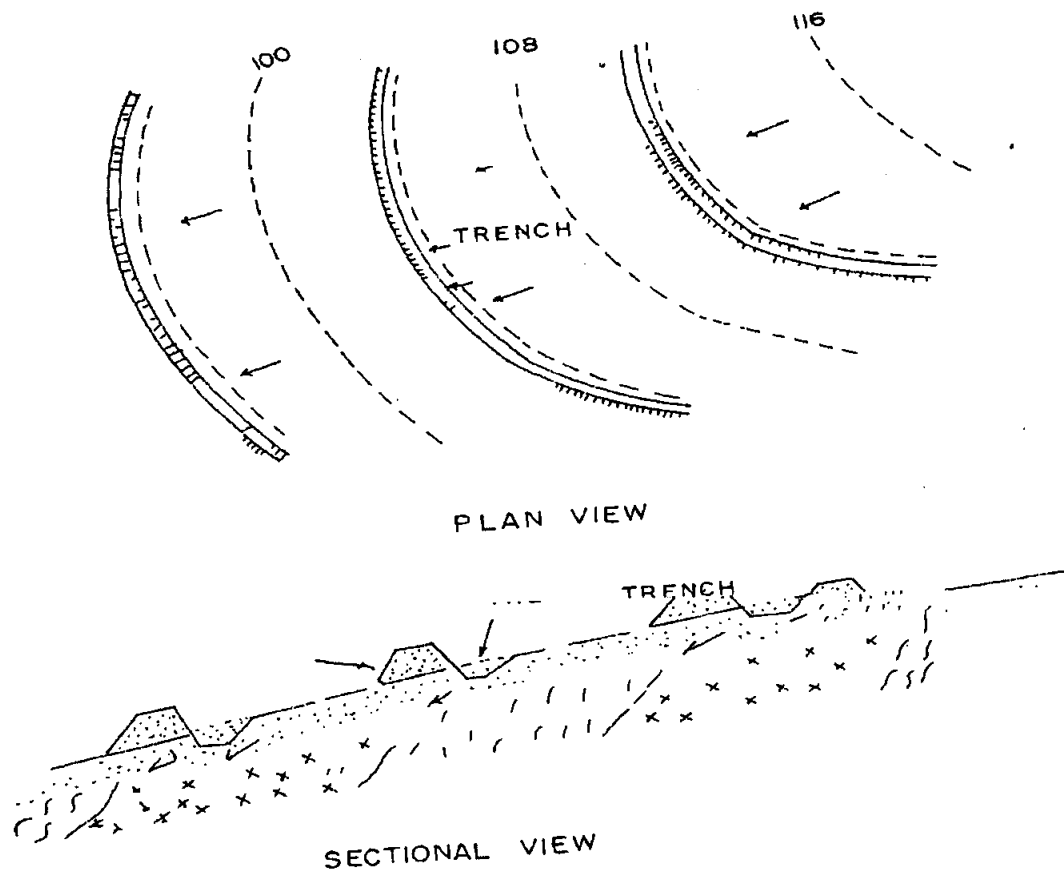

Figure showing the Percolation Ponds

2. CONTOUR BUNDING

It is a watershed management practice aimed at building up soil moisture storage involves construction of small embankments or bunds across the slope of the land. They derive their names from the construction of bunds along contours of equal land elevation. This technique is generally adopted in areas where gently sloping agricultural lands with very long slope lengths are available and the soils are permeable. Schematic of a typical system of contour bunds is shown in the Fig below



Schematics of a Typical Contour Bund

Contour bunding involves construction of narrow-based trapezoidal embankments (bunds) along contours to impound water behind them, which infiltrates into the soil and ultimately augment ground water recharge.

Such types of structures are feasible in hilly area of Himachal Pradesh, Jammu & Kashmir, Uttarakhand, Sikkim & North Eastern States.

3. RECHARGE THROUGH ABANDONED DUG WELLS / BORE WELLS / TUBE WELLS

In alluvial as well as hard rock areas, there are thousands of dug wells/Bore Wells / Tube Wells which have either gone dry or the water levels have declined considerably. These can be used as structures to recharge. The ground water reservoir, storm water, tank water, canal water etc. can be diverted into these structures to directly recharge the dried aquifer. By doing so the soil moisture losses during the normal process of artificial recharge, are reduced. The recharge water is guided through a pipe to the bottom of well, below the water level to avoid scouring of bottom and entrapment of air bubbles in the aquifer. The quality of source water including the silt content should be such that the quality of ground water reservoir is not deteriorated.

- ❖ Care need to be taken to ensure that the water used for recharge is free of sand and silt.

19)

- ❖ The agricultural fields often contain contaminants in the form of fertilizer and pesticide residue. Precaution need to be taken so that these contaminants do not go into the aquifer.
- ❖ The runoff after the first rain should be diverted away from the wells into the adjacent local drain. For this purpose a small gate may be installed before the filter chamber.
- ❖ The gates can be removed/opened after the first rains have washed away the contaminants in the agricultural field. A gate can be created by a simple steel sheet. A barrier can also be created by piling of the farm soil near the entrance of the filter pit.
- ❖ Seasonal desilting of the filter chamber should be carried out before monsoon for better and faster filtration.
- ❖ Replace the filter media seasonally or as per the requirement for fast filtration.

Regular check is required for intake pipe and overflow pipe to overcome the problems of choking due to agricultural waste material.

Schematic diagrams of dug well recharge are given below:-

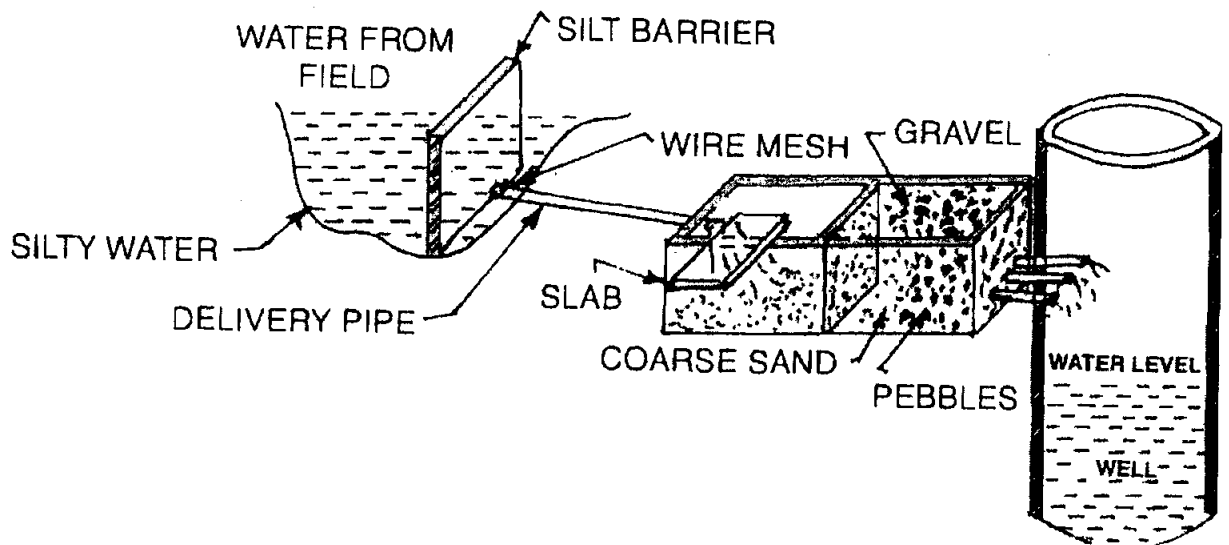

Schematics of a Dug Well Recharge Structure

113

TYPICAL DUGWELL RECHARGE STRUCTURE

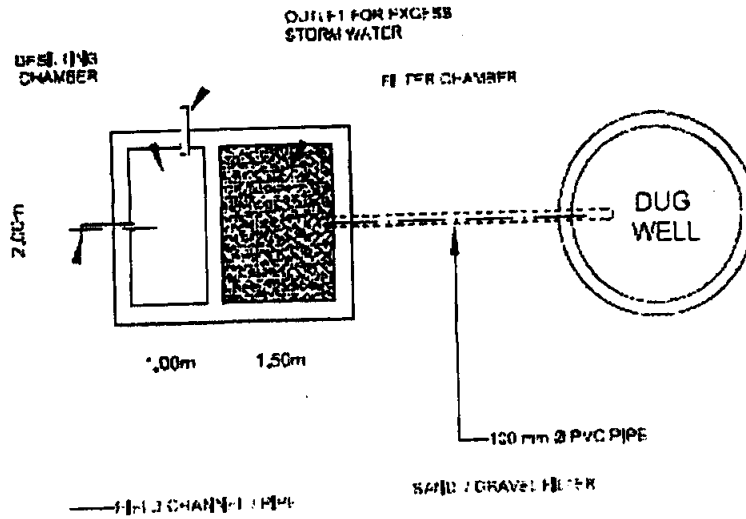

PLAN VIEW

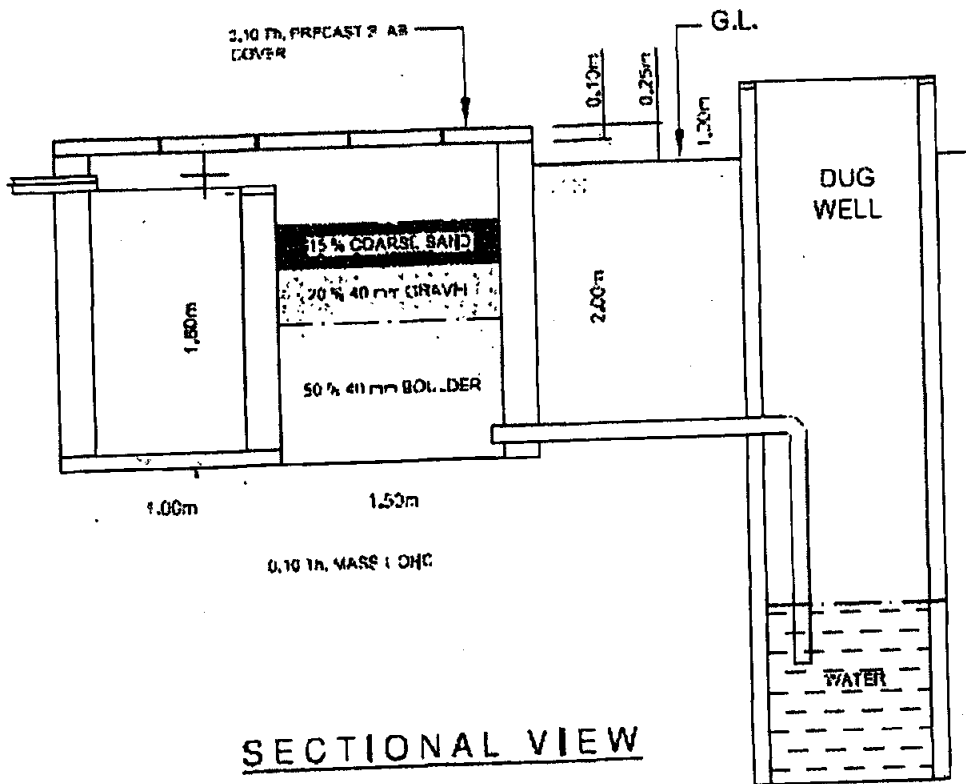

SECTIONAL VIEW

CGWB-CR/Nagpur

121



Abandoned Dug Well fitted with Rain Water Harvesting Mechanism

4. RECHARGE PITS

Recharge pits are normally excavated pits, which are sufficiently deep to penetrate the low-permeability layers overlying the unconfined aquifers. They are similar to recharge basins in principle, with the only difference being that they are deeper and have restricted bottom area. In many such structures, most of the infiltration occurs laterally through the walls of the pit as in most layered sedimentary or alluvial material the lateral hydraulic conductivity is considerably higher than the vertical hydraulic conductivity. Abandoned gravel quarry pits or brick kiln quarry pits in alluvial areas and abandoned quarries in basaltic areas can also be used as recharge pits wherever they are underlain by permeable horizons. *Nalah* trench is a special case of recharge pit dug across a streambed. Ideal sites for such trenches are influent stretches of streams.

Design Guidelines

- The recharging capacity of the pit increase with its area of cross section. Hence, it is always advisable to construct as large a pit as possible.
- The permeability of the underlying strata should be ascertained through infiltration tests before taking up construction of recharge pits.
- The side slopes of recharge pits should be 2:1 as steep slopes reduce clogging and sedimentation on the walls of the pit.
- Recharge pits may be used as ponds for storage and infiltration of water or they may be back-filled with gravel sand filter material over a layer of cobbles/boulders at the bottom. Even when the pits are to be used as ponds, it is desirable to provide a thin layer of sand at the bottom to prevent the silt from clogging permeable strata.
- As in the case of water spreading techniques, the source water being used for recharge should be as silt-free as possible.

- The bottom area of the open pits and the top sand layer of filter-packed pits may require periodic cleaning to ensure proper recharge. Recharge pits located in flood-prone areas and on streambeds are likely to be effective for short duration only due to heavy silting. Similar pits by the sides of streambeds are likely to be effective for longer periods.
- In hard rock areas, streambed sections crossing weathered or fractured rocks or sections along prominent lineaments or intersection of lineaments form ideal locations for recharge pits.

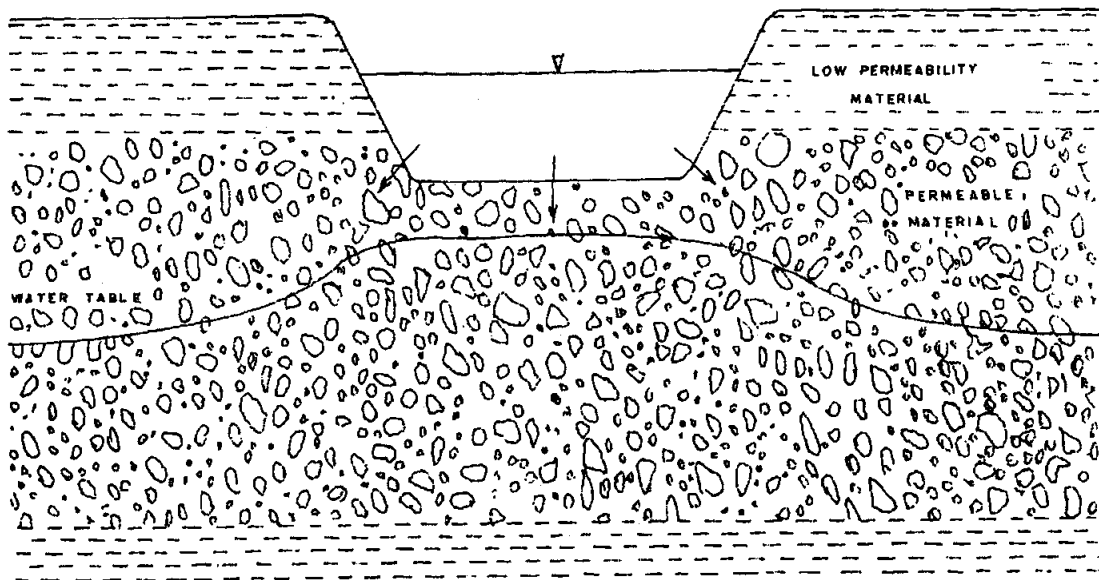

Schematics of a Recharge Pit

5. GABION STRUCTURE

This is a kind of check dam commonly constructed across small streams to conserve stream flows with practically no submergence beyond stream course. A small bund across the stream is made by putting locally available boulders in a mesh of steel wires and anchored to the stream banks. The height of such structures is around 0.5 m and is normally used in the streams with width of less than 10 m. The excess water over flows this structure storing some water to serve as source of recharge. The silt content of stream water in due course is deposited in the interstices of the boulders in due course and with growth of vegetation, the bund becomes quite impermeable and helps in retaining surface water run off for sufficient time after rains to recharge the ground water body. These structures are common in the states of Maharashtra, Madhya Pradesh, Andhra Pradesh, Bihar, Gujarat, Himachal Pradesh, Jammu & Kashmir.

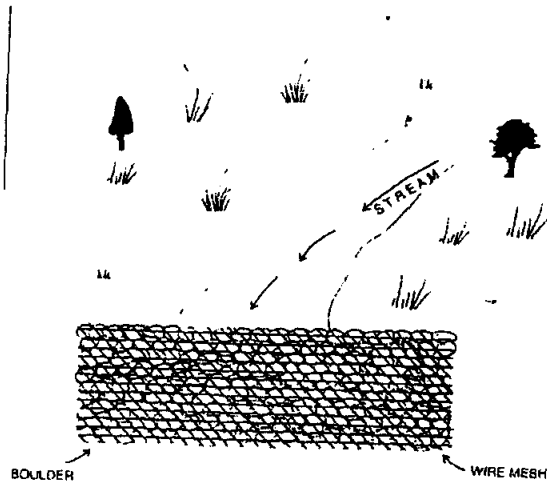

Schematics of a Gabion Structure



GABION WEIR

Gabion Structure

6. MODIFICATION OF VILLAGE TANKS AS RECHARGE STRUCTURE

In India, tanks/ponds and lakes have traditionally played an important role in conserving water for meeting various needs of the communities. As per 3rd Minor Irrigation Census 2000-2001, there are 5.56 Lakh tanks and storages in the country. Out of 5.56 lakh tanks, 4.71 lakh tanks are in use, and the remaining 0.85 lakh tanks are not in use for one reason or the other. These existing village tanks which are normally silted and damaged can be modified to serve as recharge structure. In general no "Cut Off Trench" (COT) and Waste Weir is provided for village tanks. Desilting, coupled with providing proper waste weir and C.O.T. on the upstream side, the village tanks can be converted into recharge structure. Several such tanks are available which can be modified for enhancing ground water recharge. Some of the tanks in

Maharashtra and Karnataka have been converted into percolation tanks. Such tanks are available in plenty in Jammu & Kashmir and rural areas of Tamil Nadu, they could be converted into cost-effective structures for augmenting ground water recharge with minor modifications.



Desilted ponds at Kondayampalli, Salem, Tamil Nadu

7. RAIN WATER HARVESTING THROUGH GULLY PLUG

Gully Plugs are built using local stones, clay and bushes across small gullies and streams running down the hill slopes carrying drainage to tiny catchments during rainy season. Gully Plugs help in conservation of soil and moisture. The sites for gully plugs may be chosen whenever there is a local break in slope to permit accumulation of adequate water behind the bunds. These are suitable for Hilly and Inter-mountainous area like Himachal Pradesh, Jammu & Kashmir, Uttarakhand, Sikkim & North Eastern States.



Gully Plug

8. RAIN WATER HARVESTING THROUGH RECHARGE SHAFT

This is the most efficient and cost effective technique to recharge unconfined aquifer overlain by poorly permeable strata. Recharge shaft may be dug manually if the strata is of non-caving nature. The diameter of shaft is normally more than 2 m. The shaft should end in more permeable strata below the top impermeable strata. It may not touch water table. The unlined shaft should be backfilled, initially with boulders/ cobbles followed by gravel and coarse sand. In case of lined shaft the recharge water may be fed through a smaller conductor pipe reaching up to the filter pack. These recharge structures are very useful for village ponds where shallow clay layer impedes the infiltration of water to the aquifer. It is seen that in rainy season village tanks are fully filled up but water from these tanks does not percolate down due to siltation and tubewell and dugwells located nearby remains dried up. The water from village tanks get evaporated and is not available for the beneficial use. By constructing recharge shaft in tanks, surplus water can be recharged to ground water. Recharge shafts of 0.5 to 3 m. diameter and 10 to 15 m. deep are constructed depending upon availability of quantum of water. The top of shaft is kept above the tank bed level preferably at half of full supply level. These are back filled with boulders, gravels and coarse sand. In upper portion of 1 or 2 m depth, the brick masonry work is carried out for the stability of the structure. Through this technique all the accumulated water in village tank above 50% full supply level would be recharged to ground water. Sufficient water will continue to remain in tank for domestic use after recharge.

The Schematics of Recharge Shafts is shown the fig given below:-

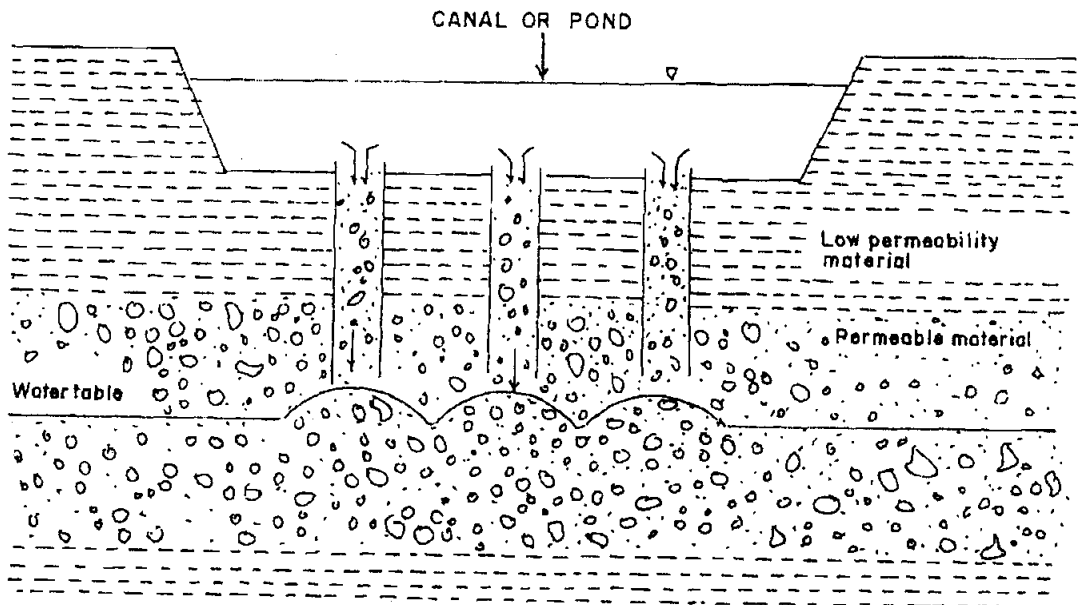

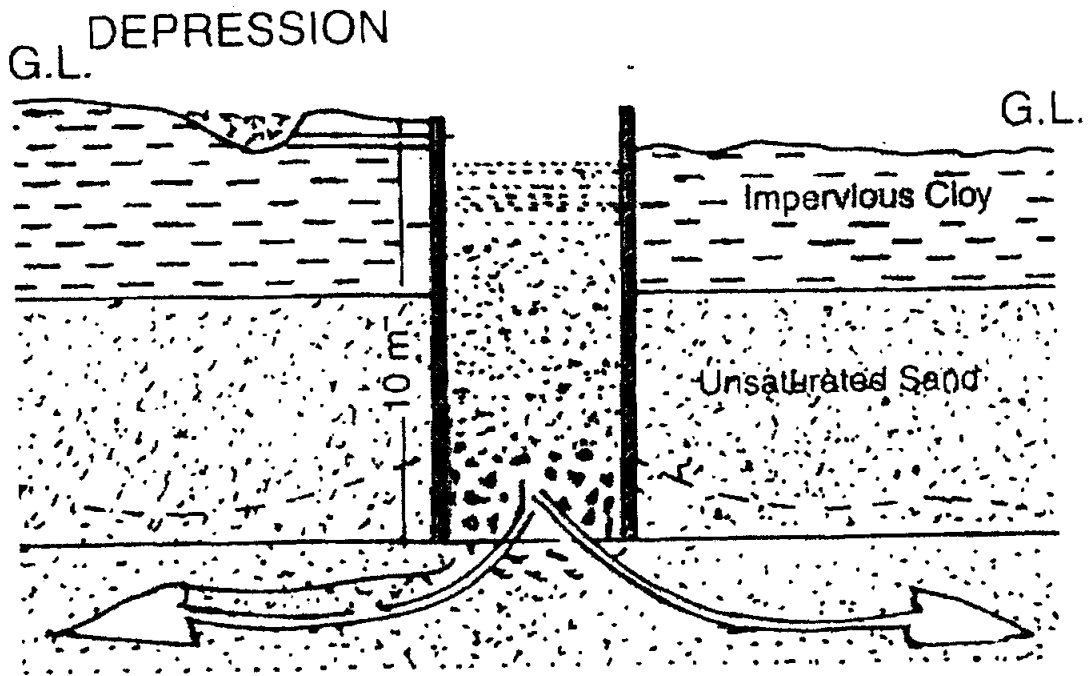

Schematics of Recharge Shafts

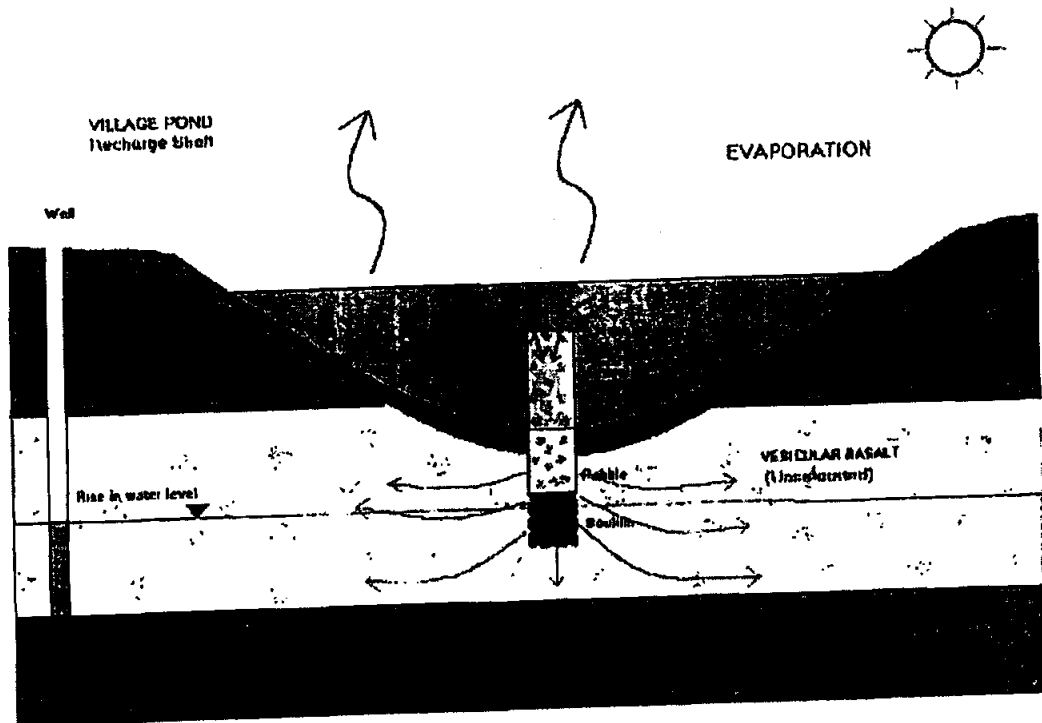

Recharge Shafts in a Village Pond

9. ROOF TOP RAINWATER HARVESTING

The concept of rainwater harvesting involves 'tapping the rainwater where it falls'. A major portion of rainwater that falls on the earth's surface runs off into streams and rivers and finally into the sea. An average of 8-12 percent of the total rainfall recharge only is considered to recharge the aquifers. The technique of rainwater harvesting involves collecting the rain from localized catchment surfaces such as roofs, plain / sloping surfaces etc., either for direct use or to augment the ground water resources depending on local conditions.

Components of Roof Top Rainwater Harvesting System

In a typical domestic roof top rainwater harvesting system, rainwater from the roof is collected in a storage vessel or tank for use during periods of scarcity. Such systems are usually designed to support the drinking and cooking needs of the family and comprise a roof, a storage tank and guttering to transport the water from the roof to the storage tank. In addition, a first flush system to divert the dirty water, which contains debris, collected on the roof during non-rainy periods and a filter unit to remove debris and contaminants before water enters the storage tank are also provided. Therefore, a typical Roof top Rainwater Harvesting System comprises following components:

- Roof catchment.
- Drain pipes
- Gutters
- Down pipe
- First flush pipe.
- Filter unit
- Storage tank.
- Collection sump.
- Pump unit
- Recharge Structure

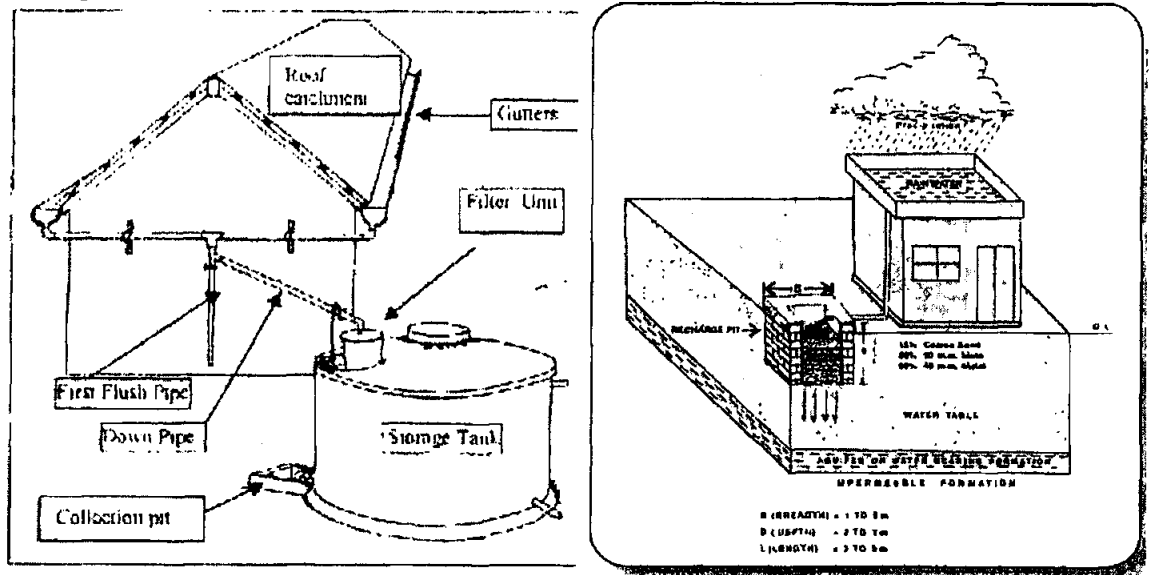

A Typical Rainwater Harvesting System

15

Among the above components, storage tank and filter unit are the most expensive and critical components. The capacity of the storage tank determines the cost of the system as well as its reliability for assured water supply whereas the filter unit assures the quality of the supplied water.

Roof top rainwater harvesting for artificial recharge to ground water where surface storage space is inadequate is to be carried out using rain water for ground water recharge. The rain water from runoff/pavement is harvested and diverted through filter media to recharge structure such as recharge shaft, trench, dugwell, abandoned tube well, hand pump etc for artificial recharge to ground water.
